

Data Sheet



Article number: 03705016

Description: Fluro rod end BRM 16 L
threaded left with ball bearing

Measures

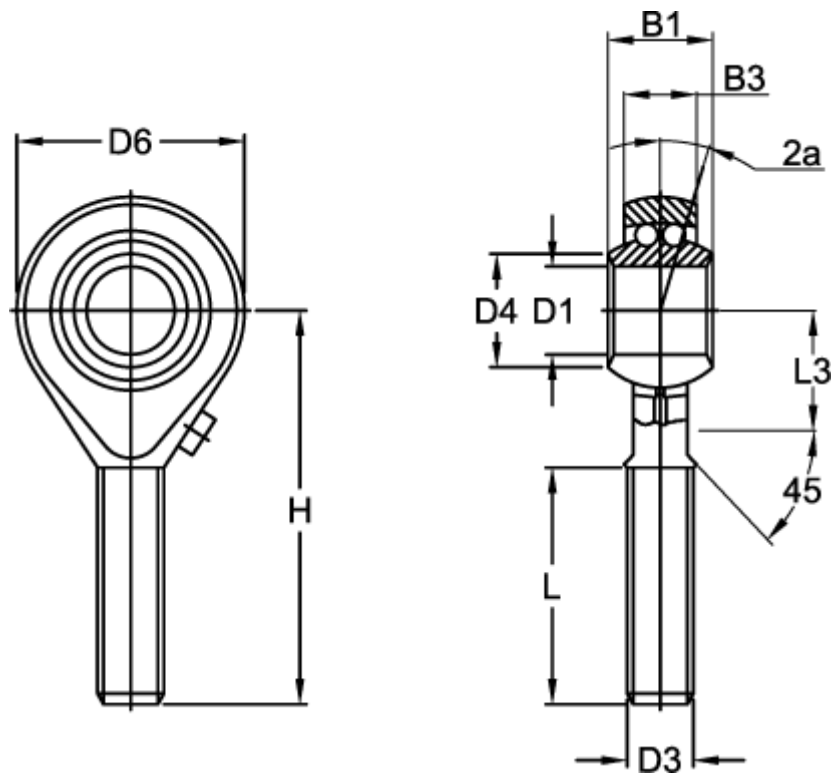

Angel 2a	= 8.0	H	= 66
B1	= 21	L	= 40
B3	= 15.00	L3	= 22
D1	= 16	Max rpm	= 975
D3	= M16x2	Static load (N)	= 2350
D4	= 19.0	Weight (kg)	= 0.190
D6	= 42		
Dynamic load C (N)	= 6250.0		